

Specifications:  
 Current Rating:9.0A AC/DC  
 Voltage Rating:600V AC/DC  
 Contact Resistance:10m Ohm. Max.  
 Insulation Resistance:1000M Ohm. Min.  
 Withstanding Voltage:1500V AC/Minute  
 Operating Temperature Range:-40°C To +105°C

Material:  
 Insulator:Nylon 66 (UL94V-0)  
 Insulator Color:White

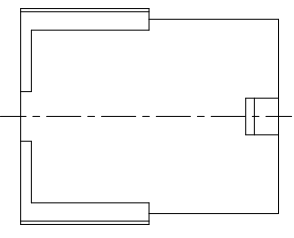
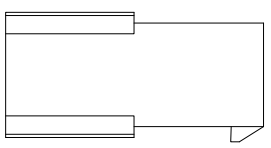
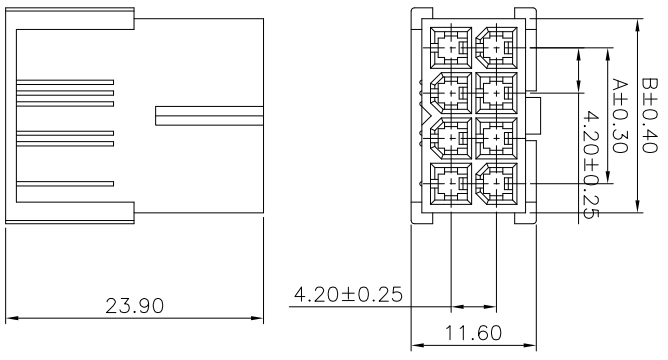

Dimension:

Pos	Dim.A	Dim.B	Pos	Dim.A	Dim.B
02	—	5.4	14	25.2	30.6
04	4.2	9.6	16	29.4	34.8
06	8.4	13.8	18	33.6	39.0
08	12.6	18.0	20	37.8	43.2
10	16.8	22.2	22	42.0	47.4
12	21.0	26.4	24	46.2	51.6

RoHS Compliant

**CnC Tech**  
 Industrial Cable and Connector Technology

REV	DATE	FILE	BY	DRAWN:	GENERAL TOLERANCE: .X = ±0.40 .XX = ±0.30	DESCRIPTION: <b>CONN PLUG DUAL 94V-0</b>	SIZE
				CHECKED:	UNIT: MM	PART NO: 4282-3-XX-D	A4
				APPROVAL:	SCALE:1:1		
					SHEET: 1 / 3		
					PROJECTION: 		

1

2

3

4

5

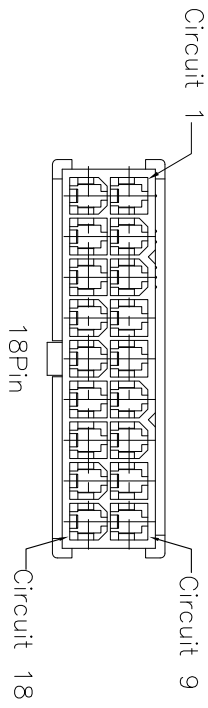
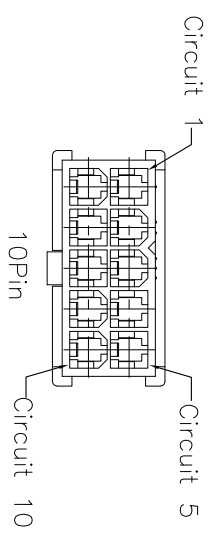
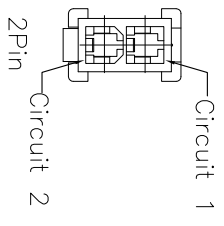
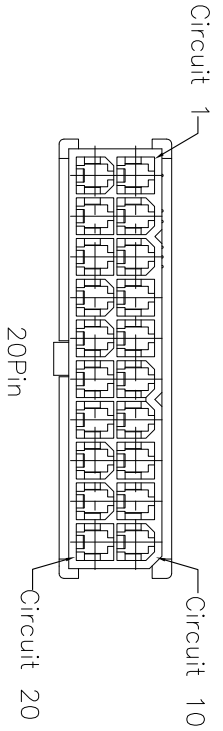
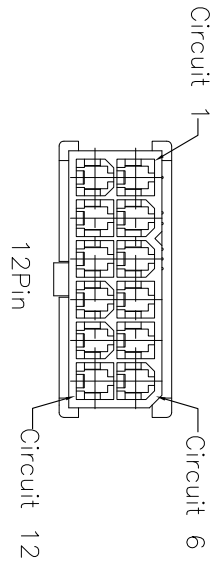
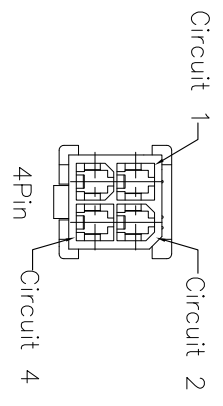
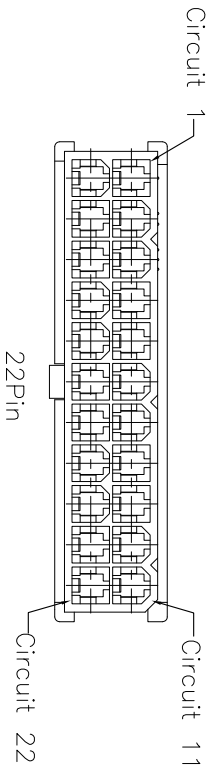
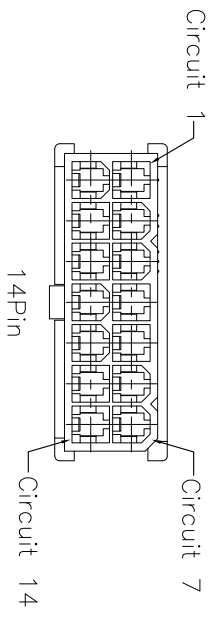
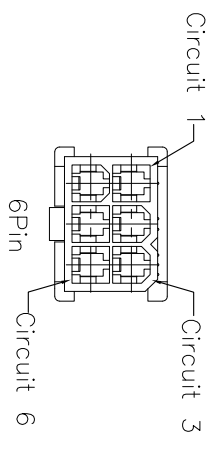
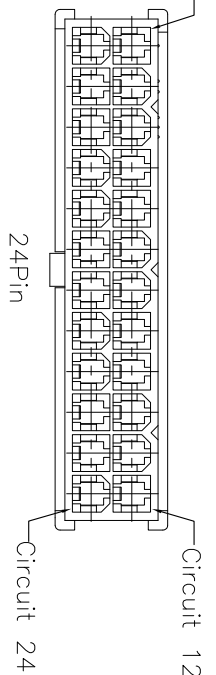
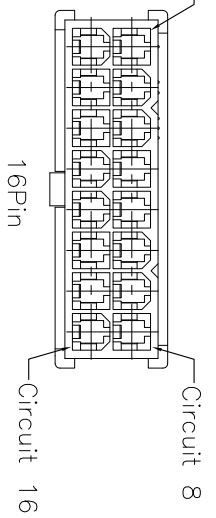
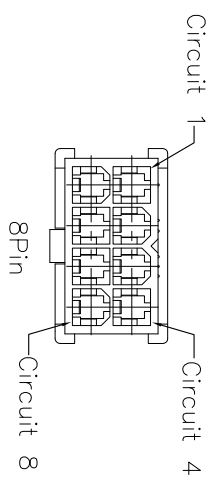

2~24P Protection Key Drawing(Ref.)

RoHS Compliant

DRAWN:		GENERAL TOLERANCE:		<b>CnC Tech</b> Industrial Cable and Connector Technology	DESCRIPTION: CONN PLUG DUAL 94V-0	SIZE A4
CHECKED:		.X = ±0.40 .XX = ±0.50				
APPROVAL:		UNIT: MM SCALE: 1:1 SHEET: 2 / 3 PROJECTION:				
REV	DATE	FILE	BY	PART NO: 4282-3-XX-D		D

A

B

C

D

Note:

1.Dimension:

Pe Bag Size:XX\*XX (mm)

Carton Size:400\*280\*280(mm)

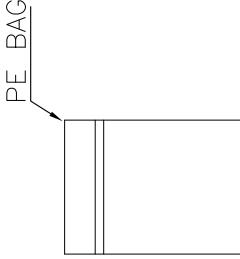
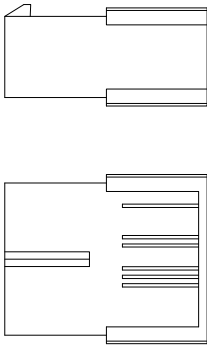
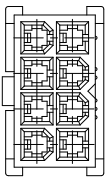

Pin.	Pcs/Bag	Pcs/Carton	Pin.	Pcs/Bag	Pcs/Carton
2	200	5600	14	100	1600
4	200	4600	16	100	1200
6	100	3000	18	100	1000
8	100	2400	20	100	1000
10	100	2000	22	50	800
12	100	1800	24	50	800

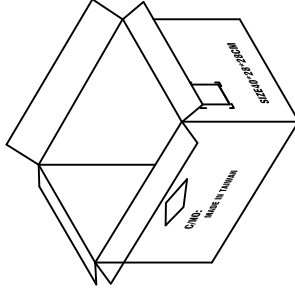

Carton

# CnC Tech

Industrial Cable and Connector Technology

GENERAL TOLERANCE:

.X = ±0.2

.XX = ±0.15

UNIT: MM

SCALE:

SHEET: 3 / 3

PROJECTION:

DESCRIPTION:

**CONN PLUG DUAL 94V-0 PACKING**

PART NO:

**4282-3-XX-D**

SIZE

**A4**

DRAWN:

CHECKED:

APPROVAL:

BY

FILE

DATE

REV