

Ha-VIS eCon 3000

Fast Ethernet Basic

PoE / PoE+



5 to 8 Ethernet ports RJ45, SC and PoE / PoE+
 Unmanaged Plug & Play Ethernet switches for DIN rail assembly in control cabinets
 Commercial Temp.: 0 °C ... +55 °C / Industrial Temp.: -40 °C ... +70 °C

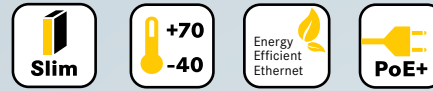

- Energy supply of up to 4 terminal devices via PoE+ (137 watts) according to IEEE 802.3at
- Fast Ethernet Non-Blocking Switch architecture according to IEEE 802.3
- Variants with industrial temperature range of -40°C ... +70 °C
- Surge protection and reverse polarity protection
- Minimum energy consumption due to Energy-Efficient Ethernet
- Optimised DIN rail bracket

Target markets

Machinery & Robotics	Automation technology	Industrial network infrastructures
Wind Energy Solar Energy	Transportation	Shipbuilding



General description

The Ha-VIS eCon 3000 Fast Ethernet PoE family of unmanaged Ethernet switches is equipped with up to 8 Fast Ethernet ports and allow for cost-efficient and quick expansion and/or reconstruction of network infrastructures. The switches work as power sourcing equipment (PSE) and are capable of simultaneously providing the full PoE output of 34.2 watts on up to four ports. The slender design of the switches enables an

extremely high packing density on the DIN rail. The selection includes various combinations of variants with RJ45 and fibre optic ports. Automatic detection of the transmission rate (auto-negotiation) and of the wiring of the twisted pair data cable (autopolarity and auto-MDI(X)) allow for simple plug & play. All variants are available with the temperature ranges „Industrial“ and „Commercial“.

Technical characteristics

Switch Features

Enclosures width	25 mm	
Number of ports	5, 6, 7, 8	
Switching technology	Store and Forward	
Supported standards	IEEE 802.3	
Frame Size	1522 bytes	
MAC table size	1k entries	
Packet buffer size	448 kbit	
Non-blocking	Yes	
Quality of service	Yes	
Energy-Efficient Ethernet	Yes	
PROFINET compatible	Yes	
EthernetIP compatible	Yes	

Voltage supply

Nominal voltage	48 VDC \equiv	54 VDC \equiv
Permissible voltage range	44 VDC ... 57 VDC \equiv	50 VDC ... 57 VDC \equiv
Surge protection	Yes	
Reverse polarity proof	Yes	
Starting current	6.40 A	7.20 A
Overcurrent protection at input	Yes (12 A)	
Max. power consumption without PoE	1.92 W ... 3.60 W	
Cross-section / Wire gauge	0.08 mm ² ... 2.5 mm ² (28 AWG ... 12 AWG)	
Connection type	3-pole, pluggable screwed contact	
Pinout	+ / - / \oplus	
Supply circuit (acc. to 60950)	SELV (circuit breaker 10 A)	

Ethernet Ports 10BASE-Te / 100BASE-TX

Connection type	RJ45
Auto-negotiation	Yes
Auto-polarity	Yes
Auto-MDI(X)	Yes
Transfer conditions	Twisted Pair
Transfer speed	10 / 100 Mbit/s
Transfer length	100 m (twisted pair, Cat 5)

Ethernet Ports 100BASE-FX

Type of fibre	Multimode (MM)	Singlemode (SM)
Connection type	SC Duplex	
Transfer conditions	FO	
Wavelength	1310 nm	
Transfer speed	100 Mbit/s	
Transfer length	2 km	15 km
Output power	-20 dBm ... -14 dBm	-15 dBm ... -8 dBm
Input sensitivity	≤ -30 dBm	≤ -32 dBm

Ambient conditions

Commercial temperature range	0 °C ... +55 °C
Industrial temperature range	-40 °C ... +70 °C
Storage temperature range	-40 °C ... +85 °C
Relative humidity (operation)	0 % ... 95 % (not-condensing)
Relative humidity (storage and transport)	0 % ... 95 % (not-condensing)
Air pressure (operation)	2000 m (795 hPa)



HARTING Technology Group
 P.O.Box 1473, D-32325 Espelkamp
 Wilhelm-Harting-Straße 1, D-32325 Espelkamp, Germany

ICPN-Service@harting.com | Service hotline: +49 5772 47-9479

Fax: +49 5772 47-405 | www.HARTING.com/de/ethernet-switches

Note: We reserve the right to make technical changes to the products and to the content of this document at any time without prior notification. The HARTING Technologiegruppe does not accept any responsibility for possible errors or incompleteness in this document. We reserve all the rights to this document and the topics and illustrations contained within it. Copying, disclosure to third parties or use of its content - even partially - is forbidden without the prior written consent of the HARTING Technologiegruppe.

PoE	PoE	PoE+
Number of PoE ports	4	
Standard	IEEE 802.3af / IEEE 802.3at	
PoE type	PSE	
Supported mode	Alternative A	
Supply voltage PSE	48 VDC \equiv	54 VDC \equiv
Max. current consumption PSE	1380 mA	2380 mA
Max. current	375 mA	638 mA
Maximum output power PSE	15.4 W per port 61.6 W total	34.2 W per port 136.8 W total
Supported cabling	See 802.3at, section 33.1.4	
PoE pinout	Alternative A, MDI-X (1/2 = V-, 3/6 = V+)	

Status and diagnostic displays

Power („Pwr“) \odot lights up green	Supply voltage is applied
Link/Activity („L/A“) off	No link
Link/Activity („L/A“) lights up green	Link is active
Link/Activity („L/A“) lights up green	Link is active and data is transferred
Link speed („Spd“) off	10 Mbit/s
Link speed („Spd“) lights up yellow	100 Mbit/s
PoE status P off	PoE is inactive / low voltage
PoE status P lights up green	Voltage in PoE range
PoE status P lights up blue	Voltage in PoE+ range
PoE status P lights up red	Error

Enclosures

Enclosures width	25 mm
Dimensions H x W x D (without pluggable screw contact and holding bracket)	142 mm x 25 mm x 107.5 mm
Weight	480 g ... 508 g
Type of installation	35 mm DIN rail acc. to EN 60 715
Material enclosures	Anodised aluminium / Powder-coated steel sheet
Protection degree (with plugged screw contact)	IP30
Degree of protection	III

Approvals

CE, FCC CFR 47 Part 15, cUL US 508 listed, DNV GL, LR, NK, ABB IIT ECE - Approval mark (E1): see table technical characteristics

EMC and environmental conditions

EMC Interference immunity (EN 61000-6-1, 61 000-6-2 55024)

Electrostatic discharge (ESD) EN 61 000-4-2
Electromagnetic field EN 61 000-4-3
Rapid transients (burst) EN 61 000-4-4
Surge voltages EN 61 000-4-5
Conducted interference voltages EN 61 000-4-6

EMC Interference emission (EN 61000-6-4, EN 55 032, FCC CFR 47 Part 15)

Mechanical stability (EN 60721-3)

IEC 60068-2-6 Vibration
IEC 60068-2-6 Vibration resonance search
IEC 60068-2-27 Shock test

Included in delivery

- Pluggable screw contact for voltage supply
- Assembly instruction

Drawings

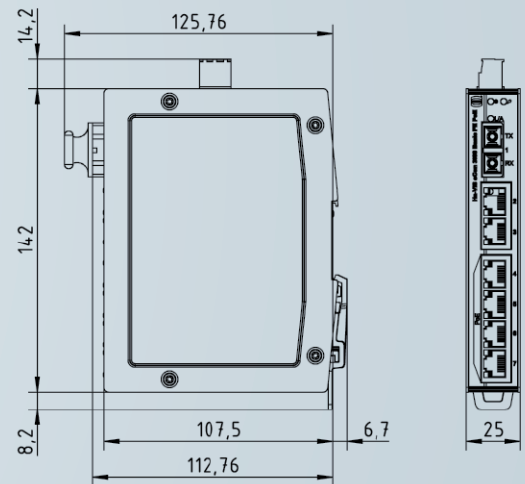

Technical characteristics / order information

Ports / order information

RJ45	SFP	SC	Enclosures width	Current consumption@ 54 VDC with PoE	MTBF in Mio. h	Commercial Temp.: 0 °C ... +55 °C		Industrial Temp.: -40 °C ... +70 °C	
						Switch	Part no.	Switch	Part no.
4	-	1x MM (2 km)	25 mm	2.41 A	1.19	Ha-VIS eCon 3041B-AD-P	24 03 004 1130	Ha-VIS eCon 3041BT-AD-P	24 03 004 1120
4	-	1x SM (15 km)	25 mm	2.41 A	1.19	Ha-VIS eCon 3041B-AF-P	24 03 004 1230	Ha-VIS eCon 3041BT-AF-P	24 03 004 1220
4	-	2x MM (2 km)	25 mm	2.43 A	1.17	Ha-VIS eCon 3042B-AD-P	24 03 004 2130	Ha-VIS eCon 3042BT-AD-P	24 03 004 2120
4	-	2x SM (15 km)	25 mm	2.43 A	1.17	Ha-VIS eCon 3042B-AF-P	24 03 004 2230	Ha-VIS eCon 3042BT-AF-P	24 03 004 2220
6	-	-	25 mm	2.40 A	1.18	Ha-VIS eCon 3060B-A-P	24 03 006 0030 ¹	Ha-VIS eCon 3060BT-A-P	24 03 006 0020 ¹
6	-	1x MM (2 km)	25 mm	2.42 A	1.15	Ha-VIS eCon 3061B-AD-P	24 03 006 1130	Ha-VIS eCon 3061BT-AD-P	24 03 006 1120
6	-	1x SM (15 km)	25 mm	2.42 A	1.15	Ha-VIS eCon 3061B-AF-P	24 03 006 1230	Ha-VIS eCon 3061BT-AF-P	24 03 006 1220
8	-	-	25 mm	2.40 A	1.14	Ha-VIS eCon 3080B-A-P	24 03 008 0030 ¹	Ha-VIS eCon 3080BT-A-P	24 03 008 0020 ¹

¹E1 Approval